

OPERATOR'S MANUAL COINMASTER 6000/Di SERIES 3 AND 5900/Di PROFESSIONAL

ATTENTION

To use your instrument under average conditions, set each of the controls to their  position.

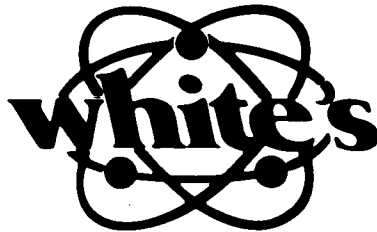
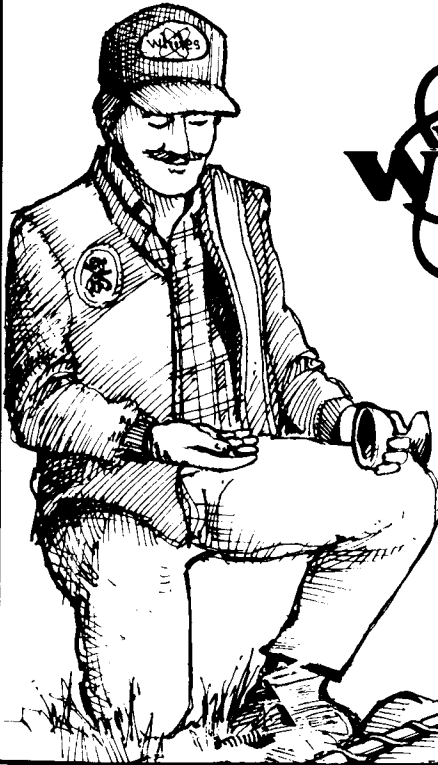

INDEX

PARTS IDENTIFICATION AND ASSEMBLY	4-5
EXPLANATION OF CONTROLS	
POWER	6
TUNER	7
VOLUME	8
MODE	9
MODE: GEB/NORM	10
MODE: GEB/DISC	11
MODE: TR/DISC	12-13
MODE: GEB/MAX	13
GEB	14-15
DISC	16-17
TRIGGER SWITCH	18
METER	19
SEARCH METHODS	20-21
STANDARD BATTERIES	22
RECHARGEABLE BATTERIES	22
OPERATING THE CHARGER	23
CAUTIONS ABOUT THE BATTERIES	23
PROPER CARE OF YOUR DETECTOR	24
A NATIONAL SERVICE PROGRAM	25
WARRANTY	26
CODE OF ETHICS	27

PARTS IDENTIFICATION AND ASSEMBLY

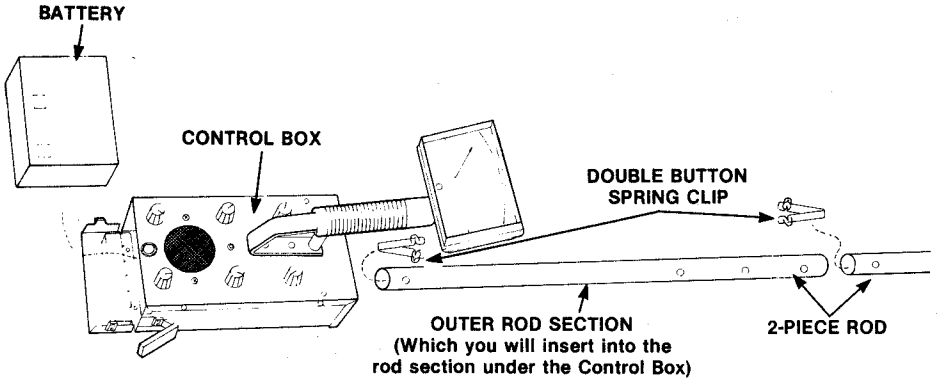

CLIP-ON STAND: (Not Shown)
Snaps onto rod section
under the Control Box

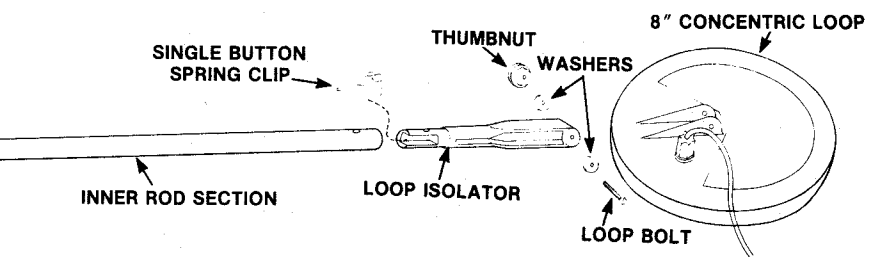

COINMASTER
Assembled and ready to go!

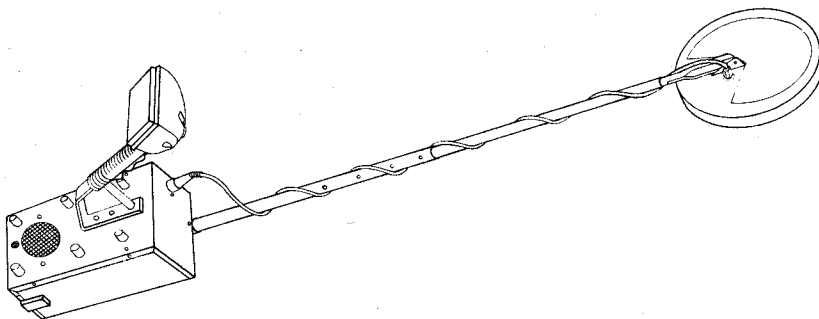

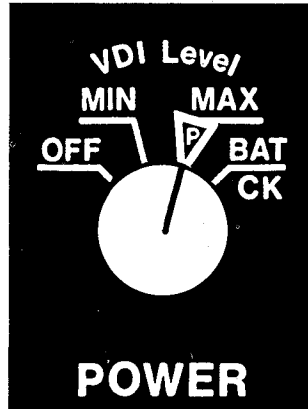
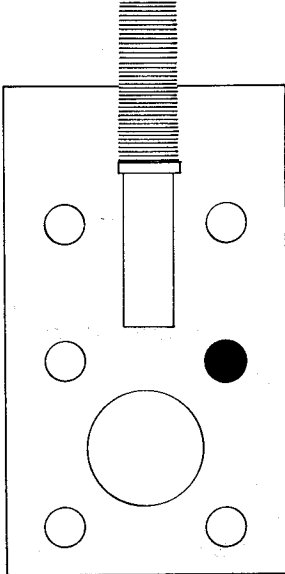

EXPLANATION OF CONTROLS: POWER

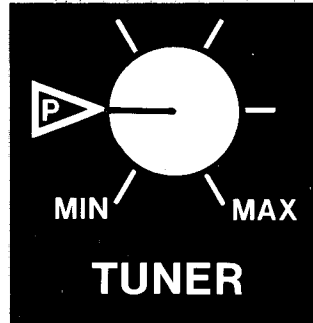
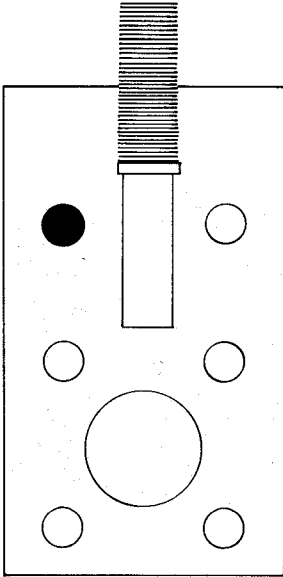

1. The POWER control turns the detector on and off, selects VDI levels and tests the battery strength.
2. The two VDI levels affect the sensitivity of the METER's Visual Discrimination Indicator.
 - a. With the VDI LEVEL at MAX, the METER's Visual Discrimination Indicator will operate at maximum depth because its sensitivity is at its highest.
 - b. Set the VDI LEVEL at MIN, only if the METER is unstable at the MAX setting. This may be necessary in areas of high mineralization, high tension power lines, or radio interference.
3. In the BAT CK position, the battery strength reads on the meter.

EXPLANATION OF CONTROLS: TUNER



1. The TUNER sets the detector's THRESHOLD.
2. The THRESHOLD is indicated by an audio tone that is barely heard. It represents the detector's maximum operating sensitivity.
3. To set the THRESHOLD:
 - a. Set all controls at .
 - b. Hold the detector so that its loop is in the air, straight out in front of you, waist high.
 - c. Squeeze and release the TRIGGER SWITCH and turn the TUNER to the right until the tone is barely heard. Release the TRIGGER SWITCH.
4. THE THRESHOLD NEEDS TO BE RESET (TRIGGER) WHENEVER ANY OF THE OTHER CONTROLS ARE ADJUSTED. To reset the THRESHOLD, raise the loop waist high and squeeze and release the TRIGGER.

EXPLANATION OF CONTROLS: VOLUME

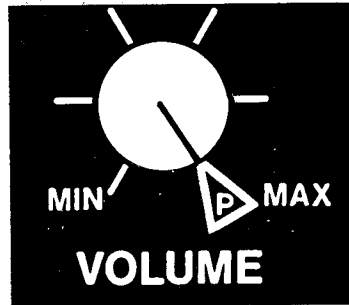
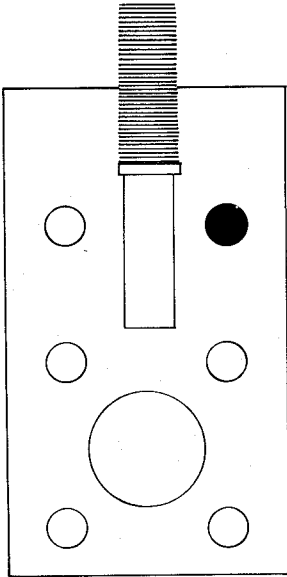

1. The **VOLUME** controls the maximum level of the audio tone.
2. The detector should be operated at maximum volume for best results.

EXPLANATION OF CONTROLS: MODE

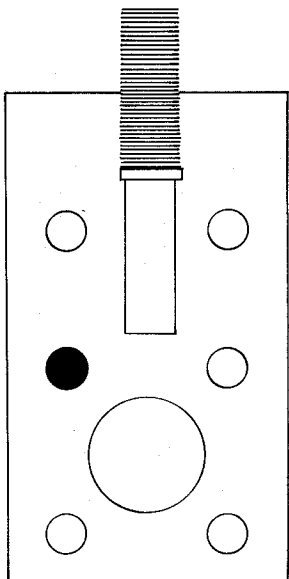

1. The MODE switch selects one of the detector's 4 modes of audio detection.
2. Each MODE is designed for specific search conditions. These conditions include soil mineralization; amount of junk cluttering the area; and the targets to be located.
3. Each mode produces an audio response. It does NOT effect the METER.
4. Each mode is explained in detail on the following pages.

EXPLANATION OF CONTROLS: MODE: GEB/NORM

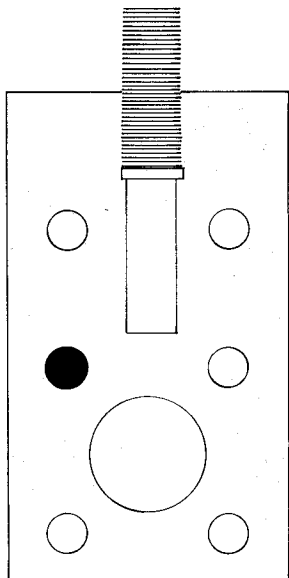

1. The GEB/NORM MODE locates ALL METALS while neutralizing the effects of ground mineralization.
 - a. This MODE may best be used for prospecting, relic hunting and coin hunting in areas where there is little junk, (like pull tabs, nails, bottle caps and etc.)
2. In the GEB/NORM MODE, it must be ground balanced using the GEB control. (See pages 14 & 15.)
3. In GEB/NORM, the loop DOES NOT have to be in motion.

EXPLANATION OF CONTROLS: MODE: GEB/DISC

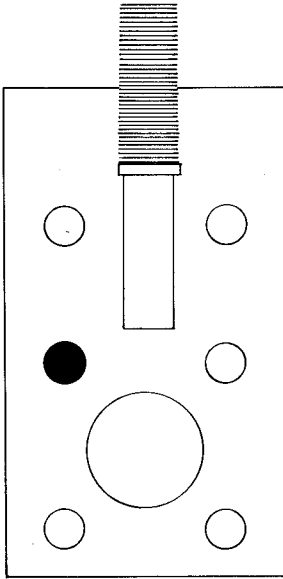

1. The GEB/DISC MODE will DISTINGUISH BETWEEN DESIRABLE AND UNDESIRABLE OBJECTS while neutralizing the effects of mineralization.
 - a. This MODE may best be used for coin hunting in areas where there is a great deal of junk, (such as pull tabs, nails and bottle caps, etc.)
2. The DISC control must be adjusted in order for you to audibly distinguish between desirable and undesirable targets. (See page 16.)
3. In GEB/DISC, the loop MUST be in motion. This is a slow sweep mode.
4. When switching modes with the TRIGGER, the instrument should be ground balanced (See pages 14 & 15.).

EXPLANATION OF CONTROLS:

MODE: TR/DISC

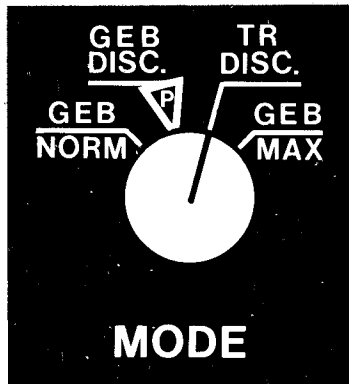
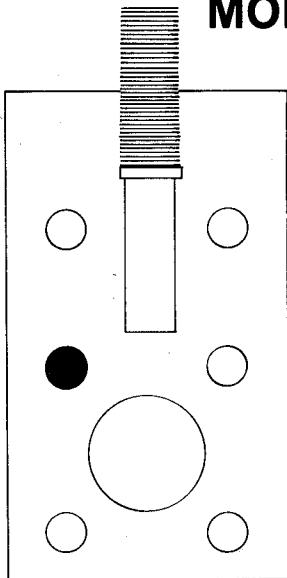

TR DISC MODE HAS TWO FUNCTIONS:

1. Provides audio discrimination between desirable and undesirable targets but will not neutralize the effects of ground mineralization at the same time.
 - a. This may be used for prospecting, searching in areas with low amounts of mineralization and in areas where there is no room to "swing" the loop (as is necessary with the GEB/DISC mode).
 - b. In this function the DISC control is adjusted to distinguish between desirable and undesirable targets. (See page 16.)
 - c. To tune the detector in this mode proceed as follows:
 1. Tune to THRESHOLD as described on page 7.
 2. Lower the loop to approximately $\frac{1}{2}$ " above the ground.
 3. Squeeze and release the TRIGGER SWITCH to reset THRESHOLD.
 - d. Search with the loop level to the ground and as close to the ground as possible.
- NOTE: If the loop is tilted or lifted, the tone may change due to variations of the ground.
- e. When searching in TR/DISC, the loop does not have to be in motion.
 - f. This MODE gets excellent depth penetration wherever it can be used. However, if the ground is mineralized, the detector will

frequently give false signals. In mineralized ground, it is best to hunt in one of the 3 GEB MODES.

2. Provides extended Ground Balance for extreme conditions. Such as salt water beaches, unusual mineralized ground and other conditions beyond the range of the GEB control.
 - a. To use the DISC control for the above conditions; use the ground balance procedure on pages 14 & 15, substituting the DISC control for the GEB control.
 - b. The DISC control operates in the opposite rotation from the GEB control. For example, If the tone gets louder as the loop is lowered, increase (turn clockwise) the DISC.

EXPLANATION OF CONTROLS: MODE: GEB/MAX

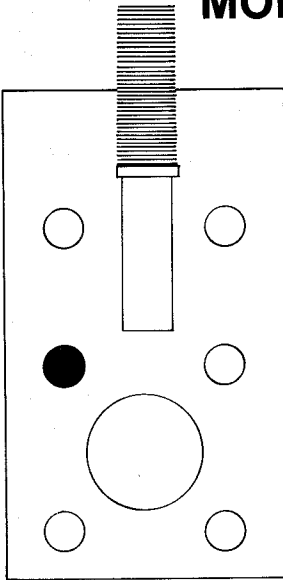

1. The GEB/MAX MODE locates all metals while neutralizing the effects of ground mineralization.
 - a. This MODE may best be used for relic hunting, and for locating very deep targets in areas where there is little junk, (like pull tabs, nails, bottle caps and etc.)
2. In the GEB/MAX MODE, it must be ground balanced using the GEB control. (See pages 14 & 15.)
3. In GEB/MAX, the loop does NOT have to be in motion.
4. GEB/MAX has approximately 30% greater depth penetration than GEB/NORM.

NOTE: Due to the increased sensitivity of GEB/MAX, it may have a somewhat rougher tone than GEB/NORM.

EXPLANATION OF CONTROLS: GEB

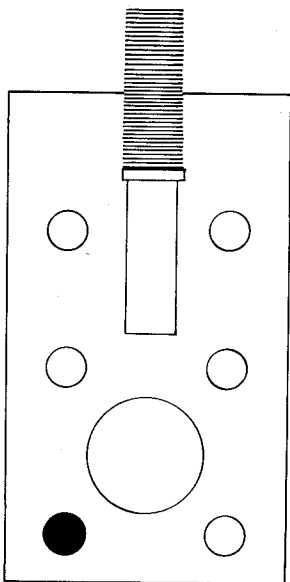

1. The GEB (Ground Exclusion Balance) control is used with all 3 GEB MODES to neutralize the effects of ground mineralization. This ground balances the detector.
2. THE DETECTOR NEEDS TO BE GROUND BALANCED EVERY TIME YOU BEGIN SEARCHING AN AREA. To Ground Balance the detector, set the controls as follows:

TUNER	MODE	GEB	VOLUME	POWER	DISC
THRESHOLD (See Pg. 7)	GEB/NORM or GEB/MAX	▽ P	▽ P	▽ P	▽ P

- a. Lower the loop to the ground. If the tone does not change, the unit is Ground Balanced.
- b. If the THRESHOLD tone changes, raise the loop waist high and turn the GEB control SLIGHTLY LEFT IF THE TONE INCREASED OR SLIGHTLY RIGHT IF THE TONE DECREASED.
- c. Squeeze and release the TRIGGER SWITCH. Lower the loop back down to the ground and note any change in tone.

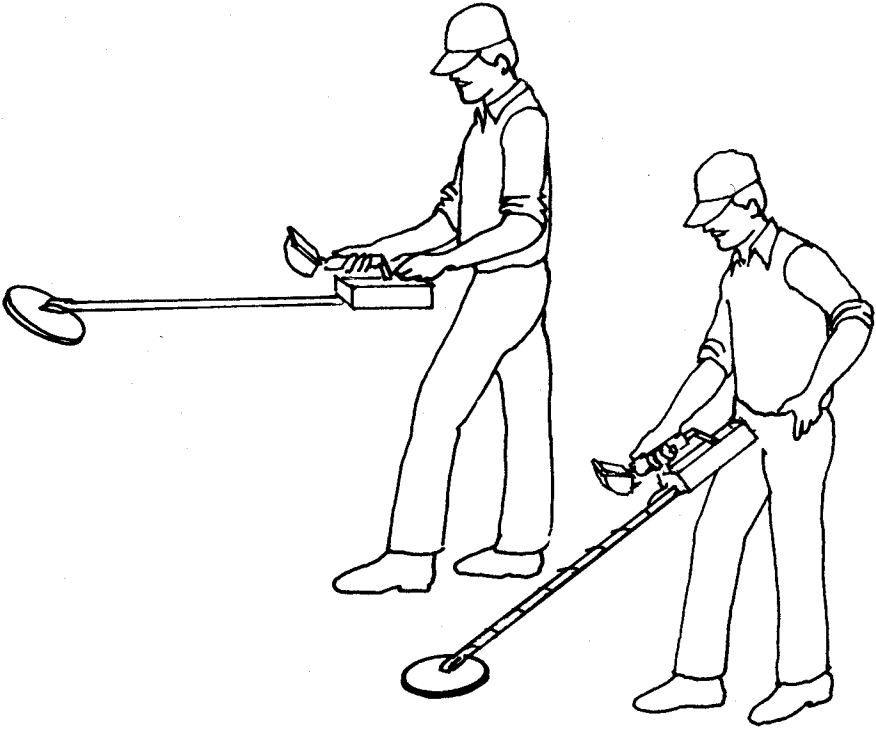

- d. Adjust the GEB control as explained in (b) until there is no change in the tone between air and ground.
- e. If you have any trouble adjusting the GEB control to a constant threshold, you may be over some metal. Move to another spot and repeat the above steps.

NOTE: Squeeze and release the TRIGGER SWITCH after each adjustment to the GEB control.

- 3. When you want to search using the GEB/DISC mode, do the following:
 - a. Ground Balance the detector in either GEB/NORM or GEB/MAX, as described above.
 - b. Turn the MODE switch to GEB/DISC.
 - c. Squeeze and release the TRIGGER SWITCH. The detector is now Ground Balanced in GEB/DISC.

FOR YOUR INFORMATION: Mineralization is the ferric oxide (iron) or magnetic content of the soil. If it is not neutralized with the GEB control, the detector will react to it and this mineralization may "hide" metal objects from the detector.

EXPLANATION OF CONTROLS: DISC

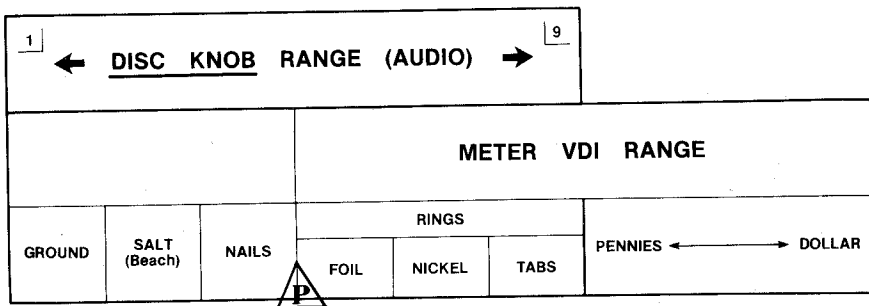
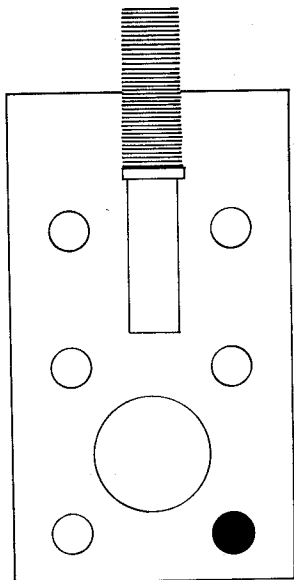

Comparison chart to illustrate the effective ranges of the VDI METER and the DISC knob.

1. The DISC (Discrimination) control works with the GEB/DISC and TR/DISC modes to help audibly distinguish between desirable and undesirable targets.

The DISC control allows the user to selectively interpret targets within the range of the above chart. The user sets the discriminate point with the knob, slightly below the desired target (see above chart).

EXPLANATION OF CONTROLS - DISC . . . Cont.

The audio response of targets ABOVE the DISC set point produce louder tones. Targets below the set point produce softer or broken tones.

EXAMPLE: With the DISC control set at , nickels and all other U.S. coins will produce a louder solid tone, nails and other iron junk will produce a broken, softer tone.

2. The DISC control effects the Audio Discriminator. It does not effect the Visual Discrimination readings.
3. Discrimination should be used only as necessary to avoid passing over desirable targets.

EXAMPLE: When the DISC control is set to reject Pull Tabs or screw caps, the U.S. nickel, some thin rings and other valuable items may also be rejected.

EXPLANATION OF CONTROLS: TRIGGER SWITCH

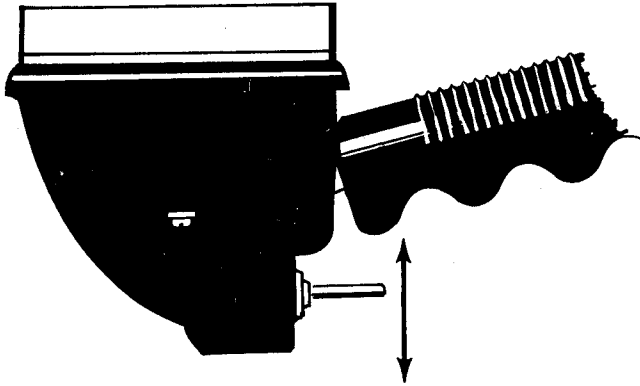

MODE SWITCH	SQUEEZED			
	TRIGGER NORMAL		TRIGGER IN	
	OPR MODE	METER	OPR MODE	METER
GEB NORM	GEB NORM	VDI	GEB DISC	DEPTH
GEB DISC	GEB DISC	VDI	GEB NORM	DEPTH
TR DISC	TR DISC	VDI	GEB MAX	DEPTH
GEB MAX	GEB MAX	VDI	GEB DISC	DEPTH

1. The TRIGGER SWITCH is a control that changes the detector's operating systems. The above chart shows these changes:
 - a. Retuning: Regain THRESHOLD by squeezing and releasing the TRIGGER SWITCH. THIS MUST BE DONE AFTER ANY CONTROL HAS BEEN ADJUSTED.
 - b. Mode Changing: Whenever the TRIGGER SWITCH is squeezed, the operating mode will change from that selected by the MODE switch. See the above chart.
 - c. Meter Switching: When the TRIGGER SWITCH is squeezed, the Meter Reading changes from Visual Discrimination to Depth Reading.
2. When the TRIGGER SWITCH is pushed forward, it locks into place, the mode and meter changes activated by squeezing the TRIGGER.

SEARCH METHODS

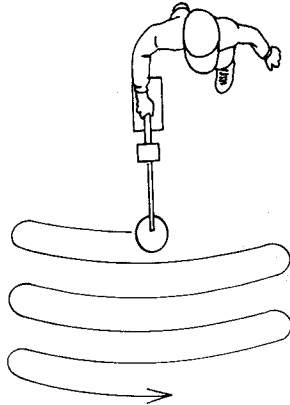

1. Always keep the loop flat and parallel to the ground. When raised, the depth penetration is decreased.
2. Swing the loop in front while searching. Each swing may cover an area from 4-6 feet in width.
3. The loop should be passed along the ground in smooth, even swings. It does not have to be swung quickly.
4. When a target is detected, sweep it from several directions, noting its Audio and Visual characteristics.
5. Before recovering an item, note its depth on the Meter. This will help avoid hitting and marring the object during removal.

PINPOINTING

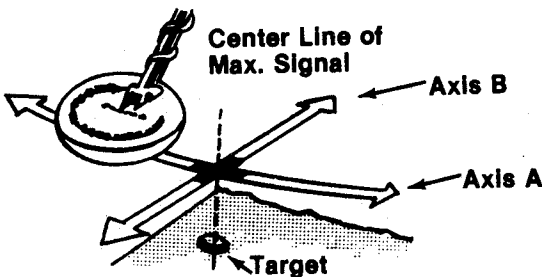

It is possible to pinpoint a target in two ways: **DE-TUNING**, using the loudest volume in the **GEB NORM** mode, or, using **DEPTH READING** with the **TRIGGER** held in.

DE-TUNING METHOD

1. Switch to **GEB NORM** mode. (This method also works in the **GEB MAX** mode.)

SEARCH METHODS . . . Cont.

2. Move the loop towards the target until the tone reaches its maximum level. At this point, move the loop across the target at a right angle until again the tone reaches its maximum level.
3. Squeeze and release the TRIGGER several times as you move the loop over the target area. You will be trying to narrow the detector's response to the target so it will be easier to know when the center of the loop is directly over the target.
4. When the target is pinpointed, move the loop off to one side.
5. Squeeze and hold in the TRIGGER (establishing DEPTH READING on the METER). Move the loop back over the target. Read the depth on the target and recover the object. NOTE: DEPTH READING is most accurate on coinsized objects.

DEPTH READING METHOD

1. Once you have determined a target is worth digging, squeeze and hold in the TRIGGER. This activates DEPTH READING on the METER.
2. Watch the METER as the loop is moved over the target area.
3. When the METER needle reaches its farthest position to the right, (the shallowest depth), the target is directly below the center of the loop. Read the DEPTH and recover.

Accurate pinpointing makes recovering objects easier; it minimizes the possibility of damaging the object; and, it minimizes damage to the area. Pinpointing is an important part of successful treasure hunting. Experience will help you develop personal techniques.

STANDARD BATTERIES

The standard battery pack holds four ALKALINE batteries. ALKALINE BATTERIES ARE THE ONLY BATTERIES RECOMMENDED FOR THIS INSTRUMENT. To insert these batteries, proceed as follows:

1. Remove the battery pack from the instrument.
2. Remove the battery pack lid by gently pulling the top sides of the pack apart until the lid springs up.
3. Note the position of each cell. (The flat side of each cell fits against one of the 4 springs.)
4. Remove the dead batteries and replace them with new ones. (If the cells are put in backwards, the detector will not work.)
5. Line up the locking tabs on the lid with the holes on the battery pack. Snap them together.
6. Insert the battery pack into the detector. The two terminal points must touch the pointed contacts inside the instrument.

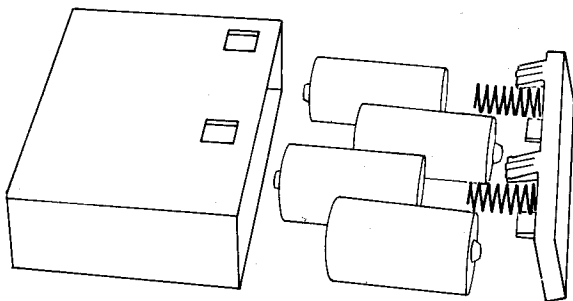

RECHARGEABLE BATTERIES

Rechargeable NICKEL CADMIUM batteries are included with the 6000/Di Series 3 and are optional items for the 5900/Di. These can be recharged up to 1000 times and should last between 8 and 12 hours after a full charge. Charge the Rechargeable Batteries before their first use.

RECHARGE THE BATTERIES:

1. If the batteries have not been recharged for more than two months. (Batteries slowly lose their charge when stored.)
2. NOTE: Charge the batteries only as necessary. Unnecessary recharging shortens the life of the battery pack.

NOTE: Batteries will last longer when headphones are used.

OPERATING THE CHARGER

1. Insert the charge plug into the battery pack. NOTE: The battery pack may be charged either in, or out of, the detector.
2. Plug the charger into an electrical outlet.
3. The pack will be fully charged within 10 hours.

CAUTIONS ABOUT THE BATTERIES

1. The battery pack should not be left on the charger more than 24 hours.
2. Do not dispose of batteries in a fire.
3. Protect the battery pack from being shorted. Burns may result and the battery pack may be damaged.
4. The rechargeable battery system, (charger and pack), has a specific charge current. Do not attempt to mix other chargers or packs with this system. Batteries may explode if a charge current is too high.
5. Non-rechargeable batteries may explode if they are recharged.
6. Store batteries in a cool, dry place.
7. THE RE-CHARGEABLE BATTERY PACK IS A SEALED UNIT WITH NO CUSTOMER SERVICEABLE PARTS. OPENING IT MAY DAMAGE THE UNIT AND WILL VOID THE WARRANTY.

PROPER CARE OF YOUR DETECTOR

The following are precautions you should take to protect your instrument from harm, ensure its long life and avoid nullifying the warranty.

CLEANING: The loop and rod or probe are waterproof. They can be cleaned with fresh water and a mild cleanser. After cleaning, however, dry the instrument thoroughly. **CAUTION:** The instrument case is not waterproof, and water - if allowed to enter it - will damage electronic components.

WEATHER CONDITIONS: Protect your detector from excessively cold weather. Freezing can damage the electronic components, the case and/or the batteries. Excessive heat can also damage the instrument. Never leave it in the sun. If it's left in a car on a hot day, cover it to protect it from the direct rays of the sun, and then leave the windows slightly open to permit ventilation. Protect your detector if you operate it in the rain, as water may get into the instrument case.

SALT WATER: Salt water is very corrosive! Immediately after your detector has been exposed to salt water, rinse it thoroughly with fresh water, being careful not to allow water to enter the instrument case. Then wipe it with a cloth dampened with fresh water and dry it thoroughly.

ADDITIONAL PRECAUTIONS:

- a. Avoid dropping your detector.
- b. Do not use any lubricants on any part of your metal detector.
- c. Avoid sharp jars to the loop.
- d. Do not allow batteries to corrode inside the instrument.
- e. Do not alter or modify your instrument during its warranty period. Alterations will void the warranty.

A NATIONAL SERVICE PROGRAM

THE SERIAL NUMBER IS ON THE SILVER TAG INSIDE THE BATTERY COMPARTMENT.

THE CODE NUMBER IS ON THE WHITE TAG.

White's Electronics has always been concerned with the absolute quality of its mineral/metal detectors. Service after-the-sale is also of equal importance. In an effort to further the quality of service to our customers, White's reorganized its warranty service program significantly. Since January 1982, there have been ten factory authorized National Warranty Service Centers located regionally around the continental U.S. These Service Centers are identical to the Factory Service Center in Sweet Home, Oregon. In order to ensure you will get the finest service possible for your detector, the technicians in each National Warranty Service Center are Factory trained and given on-going training for new products and improved service techniques. They can also repair your out of warranty instruments with efficiency and timeliness.

Simply return the detector to the dealer where you purchased the unit. The unit must be accompanied by a completed service coupon provided by your dealer. You must provide proof of date of purchase before the unit is shipped.

If the unit has failed within the first 90 days of purchase, shipping will be prepaid.

If the unit fails after the first 90-day period, the customer is responsible for shipping costs. Please also include \$5.00 for return postage, handling and insurance.

Any repair work performed by other than a White's National Warranty Service Center will automatically void the warranty.

If a problem occurs with your metal detector, first contact the White's dealer who sold it to you. In many cases your dealer can solve the problem. If not, the dealer will have your detector repaired under the Warranty Program. All of White's National Service Centers, located throughout the country, are owned and operated by factory trained technicians. These centers are fully equipped and the personnel fully trained with on-going programs at White's in order to service your mineral/metal detector. With this program, the average repair time has actually been reduced from weeks to days!

TO LEARN THE NAME AND LOCATION OF YOUR NEAREST WHITE'S DEALER CALL: TOLL FREE 1/800/547-6911

WHITE'S ELECTRONICS' LIMITED WARRANTY

If within two years (24 months) from the original date of purchase your White's detector fails through normal use or due to defects in either material or workmanship, White's Electronics will repair or replace, at its option all necessary parts without charge for parts or labor.

Simply return the detector to the dealer where you purchased it. The unit must be accompanied by a completed service coupon provided by your dealer. You must provide proof of date of purchase before the unit is shipped.

If the unit has failed within the first 90 days of purchase, shipping will be prepaid.

If the unit fails after the first 90-day period, the customer is responsible for shipping costs. Please also include \$5.00 for return postage, handling and insurance.

Items excluded from this warranty are non-rechargeable batteries, headphones and other accessories.

The warranty is not transferable. Nor is it valid unless the Warranty Registration Card is returned to the factory address below within ten (10) days of original purchase for the purpose of recording that date, which is the actual commencement date of the warranty.

The warranty does not cover damage to detectors caused by accident, misuse, neglect, alterations, modifications or unauthorized service.

Duration of any implied warranties (e.g., merchantability and fitness for a particular purpose) shall not be longer than the stated warranty.

Neither the manufacturer nor the retailer shall be liable for any incidental or consequential damages resulting from defects or failures of the instrument to perform.

Some states however, do not allow limitations on the length of implied warranties, or the exclusion of incidental or consequential damages. Therefore, the above limitations and exclusions may not apply to you.

In addition, the stated warranty gives you specific legal rights, and you may also have other rights which vary from state to state.

CODE OF ETHICS

Treasure hunting is the kind of new hobby that fires the imagination and generates its own enthusiasm. It's the most natural thing in the world to want to dig as fast as you can the minute you hear that first loud unmistakably "good" signal. It will be a real thrill to discover there's treasure right beneath your feet!

But wait a minute! We strongly urge you to adopt a code of ethics which will preserve the environment and also the rights of treasure hunters to operate detectors with as few restrictions as possible.

Before you even begin a search, check the law, ordinance or regulations about hunting on publicly owned sites. Abide by the rules. If the area is private property, get written permission from the owner to search it. You may find he will be more eager to give permission if you suggest sharing your finds with him, or if you offer to search for a specific item he has lost.

ABOUT DIGGING: In lawn areas limit the size of the hole to a maximum of two inches in diameter, cutting a plug of sod which can be easily replaced. After you take your finds, be sure to carefully fill the hole. **HOLES ARE BOTH UNSIGHTLY AND DANGEROUS!**

Detectors designed for locating large and deeply buried objects should be used with discretion - never in the lawn area, and with careful judgement in other locations. Consider the scar you may leave, before you start digging. This will vary a lot from one part of the country to another, depending on local soil and climatic conditions. Public officials and private property owners will be much more likely to allow continued treasure hunting if you do no environmental damage. You may even be able to increase your reputation as an ethical hunter by volunteering to carry out and dispose of whatever trash items you find.

Adoption of these attitudes can only enhance the public's opinion of treasure hunters and assure that many areas, both public and private, remain open to you and your new detector.

white's electronics, inc.

1011 Pleasant Valley Rd. Sweet Home, Oregon 97386

PN 821-0247

REVISED 1/86

PRINTED IN U.S.A.