

OPERATOR'S MANUAL LIBERTY II

ATTENTION:

To use your Liberty II under average conditions, set both controls at ∇ PRESET. You are now ready to detect.

Note: The search loop must be in motion to detect. To pinpoint, squeeze and hold the trigger switch while sweeping the search loop over the target slowly.

For more detailed operating instructions, refer to the information inside the manual.



**A Message from
Mr. Kenneth White, Sr.
President, White's Electronics**

Congratulations! You are now the proud owner of one of the world's finest detectors. You'll enjoy the many relaxing hours you'll spend with your new detector.

Ahead of you lie exciting experiences you'll never forget. For years to come you'll have yarns to spin about the places you'll visit, the people you'll meet, the history you'll learn, and the treasures and relics you'll uncover. We envy your journey and wish you every success.

Before we tell you how to assemble and operate your instrument, there are two important points to leave you with:

1. Your new detector is precision-made and has been carefully tested at our factory. Properly cared for, it will last for years and years. Treat it like a good friend and it should never let you down.
2. Any piece of fine equipment is only as good as the person operating it. Right now your detector is "smarter" than you, so you've got some catching up to do. Become very familiar with your instrument. Practice as much as you can. Soon it will become a part of you.

You and your metal detector will make an outstanding team. We've known many "shooters" who could follow in the tracks of others and find buried coins and rings the others had missed. You've got the equipment to out-shoot most anyone. Now all you need is the practice.

Good Hunting,

A handwritten signature in cursive script that reads "Kenneth White". The signature is written in black ink and is positioned below the "Good Hunting," text.

Kenneth White, Sr.

INDEX

PARTS IDENTIFICATION AND ASSEMBLY	2
POWER SUPPLY	3
QUICK TUNING	3
MORE ON TUNING	3
EXPLANATION OF CONTROLS	
ON-OFF SENSITIVITY	4
DISCRIMINATION CONTROL	4-5
TRIGGER SWITCH	5
HEADPHONE JACK	6
LOOPS OR SEARCH COILS	6
SEARCH METHODS	6-7
PROPER CARE OF YOUR DETECTOR	8
NATIONAL SERVICE PROGRAM	9
AUTHORIZED SERVICE CENTERS	10
WARRANTY STATEMENT	11
CODE OF ETHICS	12

For simple operating instructions for your Liberty II, follow the Quicklook explanations for each feature. More detailed explanations follow each Quicklook.

ASSEMBLY INSTRUCTIONS

1. Join connector X to Y until fully engaged. Store excess cable in grip cavity.
2. Position Control Box onto Armrest/Handle Assembly, being careful not to pinch connecting cable.
3. Hand tighten thumb screws snugly, joining Control Box to Armrest.
4. Assemble Rod, Isolator, and Loop as shown on drawing.
5. Wind first revolution of loop cable over top of loop isolator and around rod. Plug loop connector into rear of control box.
6. Install battery as shown.

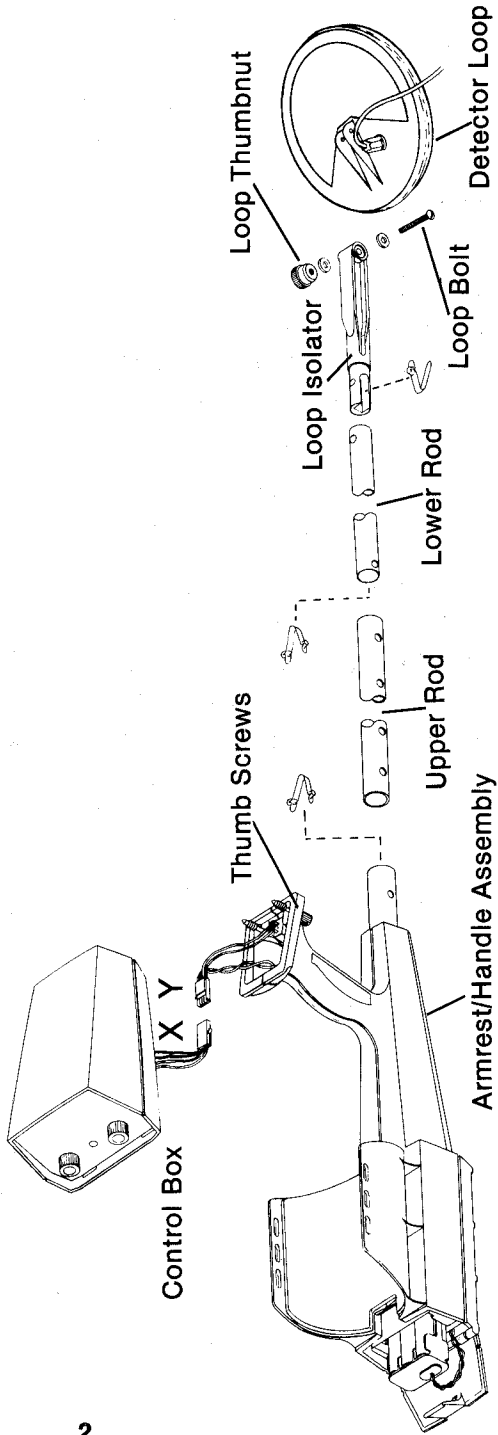

POWER SUPPLY

The Liberty II is powered by one 9 volt penlight battery pack that holds six 1½ volt AA batteries. Install 1½ volt AA batteries in the black penlight holder with the flat end of each battery against the spring in the holder. Open the battery compartment door and attach the battery lead to the battery holder. NOTE: It will only fit one way. Place the battery holder in the battery compartment and close the battery compartment door. The low battery alert will glow brightly when one or more of the 1½ volt AA batteries require replacement.

(Rechargeable battery 512-0014 and charger 509-0016 can be purchased as an accessory.)

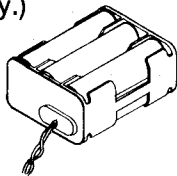

QUICKLOOK TUNING

- 1) Place both controls at ▽ PRESET.
- 2) You are now ready to detect. NOTE: The search loop must be in motion to detect. To pinpoint, squeeze and hold the trigger switch while sweeping the search loop over the target slowly.

MORE ON TUNING

Compensation for ground mineralization is built into the Liberty II circuitry.

Turn the instrument on by rotating the sensitivity control clockwise.

The sensitivity control should be used in the position as far clockwise as will produce stable operation. Unstable operation will be noted by false signals and erratic behavior of the audio tone.

Selecting the discriminate setting is a personal preference.

We recommend ▽ PRESET position. If the discriminator is set much higher, some valuable targets will discriminate out. In high trash areas, higher discrimination is a must to eliminate trash or junk targets. When a target is detected, squeeze and hold the trigger switch for pinpointing. (Note that motion is required for detection.) The clearest tone will be noted as the center of the search coil is passed directly over the target.

EXPLANATION OF CONTROLS: ON-OFF VARIABLE SENSITIVITY

QUICKLOOK

▽ PRESET POSITION IS IDEAL FOR MOST CONDITIONS.

MORE ON ON-OFF SENSITIVITY CONTROL

When the sensitivity control is completely counter-clockwise, the instrument is off. Turning clockwise, a click will indicate the instrument is on. Continuing the clockwise direction increases this unit's sensitivity. In most conditions ▽ Preset is ideal. If the instrument is unstable due to interference or ground conditions, reduce the sensitivity by turning control counter-clockwise. Some ground conditions may produce false signals and erratic behavior and may require reduced sensitivity settings. Place a coin on the ground and adjust the sensitivity control to produce a smooth tone as the loop is swept over the target. NOTE: Motion is required for this instrument to detect.

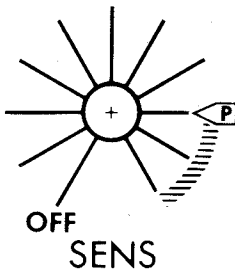

BATTERY
LOW +

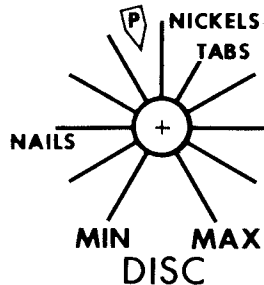

DISCRIMINATE CONTROL

QUICKLOOK

▽ PRESET IS IDEAL FOR MOST CONDITIONS.

MORE ON THE DISCRIMINATE CONTROL

The discriminate control selects the amount of discrimination or ability to reject junk targets. At a low setting, most all metals will be detected. At higher settings more junk targets will be rejected. If the discriminate control is set higher than ∇ PRESET, some valuable materials (possibly gold rings) may also be rejected.

When a target is rejected or discriminated against, it will produce a short or ratty, broken tone. Good targets produce a smooth, solid tone. Practice will familiarize you with these differences in tone. Use a bottle cap, a nail, and a coin on top of the ground and note the differences in the tone as you pass the loop over each target. NOTE: Motion is required for this instrument to detect.

EXPLANATION OF CONTROLS

TRIGGER SWITCH

Squeezing the trigger switch changes the instrument to an all metal mode and eliminates all discrimination. This is used to pinpoint the exact location of a target. When a good target has been located, squeeze and hold the trigger switch and slowly sweep the search loop over the target. NOTE: Slow motion will still be required for detection. The clearest tone will be noted when the center of the loop is directly over the target. Practice is required for accurate pinpointing. (See page 7).

The instrument can be locked into the all metal or "0" discrimination mode by placing the trigger in the far forward position. This will have the same effect as turning the discriminator knob to "0" discrimination.

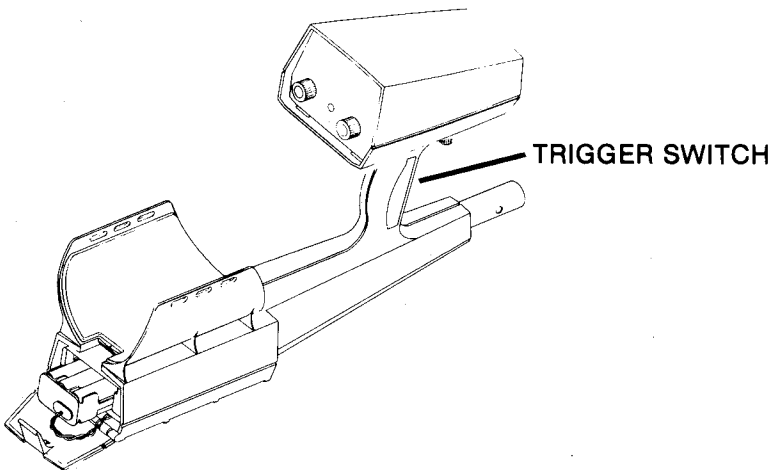

HEADPHONE JACK

The 1/8" headphone jack is located next to the loop connector and requires mono headphones. When headphones are used, the speaker is no longer operating. The use of headphones improves battery life and will also improve detection capabilities by eliminating noises from external sources.

LOOPS

The search coils or loop of the Liberty II can be interchanged with a four, eight, ten or fifteen inch, Series 2, Series 3, or Professional Series search coil. Loop adaptor part number 802-7071 will be required.

The larger the search coil, the better the depth, however, sensitivity to small targets will be reduced. The smaller the search coil, the better the sensitivity to small targets, however, a reduction in overall depth will be noted.

SEARCH METHODS

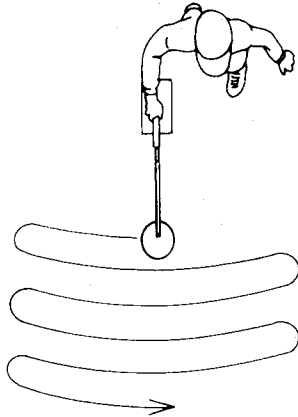

PROPER CARE OF YOUR DETECTOR

CLEANING: Both the loop and rod are waterproof and can be cleaned with fresh water and a mild soap. After cleaning, dry the instrument thoroughly. Caution! Never raise the wet loop above the level of the instrument case. The instrument case is not waterproof and water may run down the rod into the case, damaging the electronic components.

WEATHER CONDITIONS: Protect your detector from excessively cold weather. Freezing can damage the electronic components, the case and/or the battery. Excessive heat can also damage the instrument. Never leave it in the sun. It's best to lay it in the shade when not in use. If it's left in a car on a hot day, cover it to protect it from the direct rays of the sun and then leave the windows slightly open to permit ventilation. Protect your instrument if you operate it in the rain, as water may get into the instrument case. (Use a plastic bag.)

SALTWATER: Saltwater is very corrosive! After your detector has been exposed to saltwater, rinse it thoroughly in fresh water being careful not to let the loop rise higher than the level of the instrument case. Then wipe it with a cloth dampened with fresh water and dry it thoroughly.

STORAGE: If you plan to store your instrument for any length of time, unsnap the battery and remove it from the instrument. Whenever your instrument is not in use, turn the ON/OFF Tuner all the way to left until it clicks off.

ADDITIONAL PRECAUTIONS:

- a. Avoid dropping your detector.
- b. Do not use any lubricants on any part of your metal detector.
- c. Avoid sharp jars to the loop.
- d. Do not allow battery to corrode inside the instrument.
- e. Do not alter or modify your instrument during its warranty period. Alterations will void the warranty.

A NATIONAL SERVICE PROGRAM

THE SERIAL NUMBER IS ON THE SILVER TAG ON THE INSIDE TOP OF THE INSTRUMENT CASE LOOKING THROUGH THE BATTERY COMPARTMENT.

THE CODE NUMBER IS ON THE WHITE TAG.

White's Electronics has always been concerned with the absolute quality of its mineral/metal detectors. Service after-the-sale is also of equal importance. In an effort to further the quality of service to our customers, White's reorganized its warranty service program significantly. There are now four factory authorized National Warranty Service Centers located regionally around the continental U.S. These Service Centers are identical to the Factory Service Center in Sweet Home, Oregon. In order to ensure you will get the finest service possible for your detector, the technicians in each National Warranty Service Center are Factory trained and given on-going training for new products and improved service techniques. They can also repair your out of warranty instruments with efficiency and timeliness.

Simply return the detector to the dealer where you purchased the unit. The unit must be accompanied by a completed service coupon provided by your dealer. You must provide proof of date of purchase before the unit is shipped.

If the unit has failed within the first 90 days of purchase, shipping will be prepaid.

If the unit fails after the first 90-day period, the customer is responsible for shipping costs. Please also include \$5.00 for return postage, handling and insurance.

Any repair work preformed by other than a White's National Warranty Service Center will automatically void the warranty.

All of White's National Service Centers, located throughout the country, are owned and operated by factory trained technicians. These centers are fully equipped and the personnel fully trained with on-going programs at White's in order to service your mineral/metal detector. With this program, the average repair time has actually been reduced from weeks to days!

White's Factory Authorized Service Centers

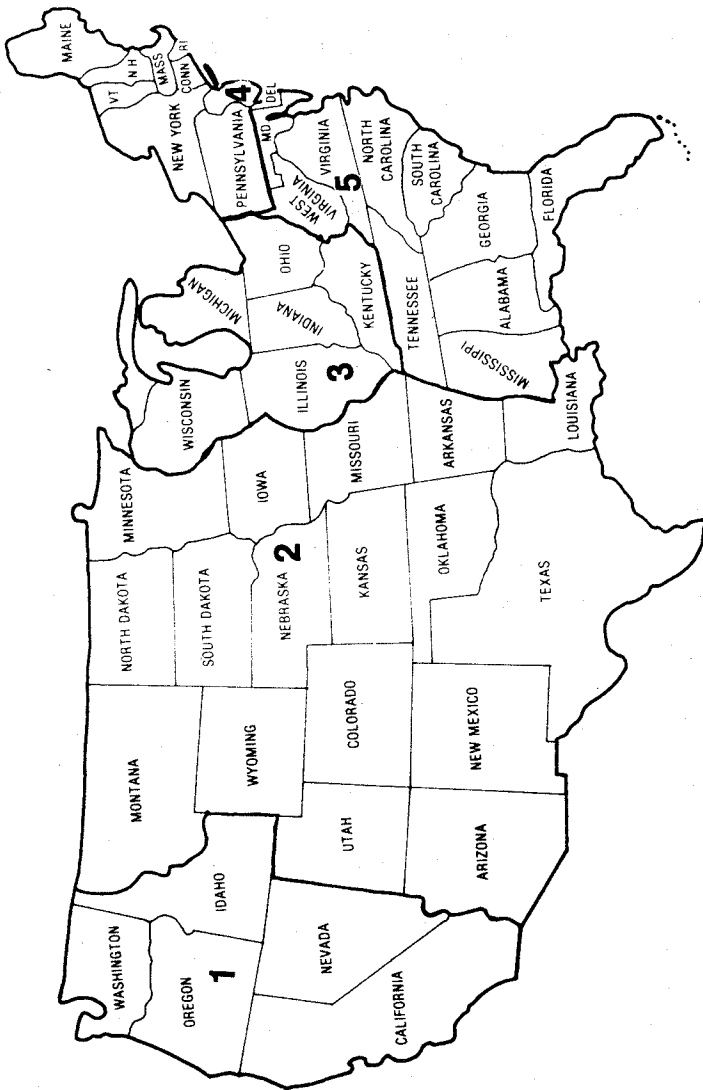

1. White's Electronics, Inc.
1011 Pleasant Valley Rd.
Sweet Home, OR 97386
(503)367-6121
2. Koci Detector Sales/Service
1917 N. Kansas St.
Hastings, NE 68901
(402)463-4705
3. Electronic Exploration
575 W. Harrison Rd.
Lombard, IL 60148
(312)620-0618
4. Geo-Quest
106 U.S. Hwy. 46
Saddlebrook, NJ 07662
(201)772-7443
5. United Metal Detectors
13821 Lee Hwy.
Centreville, VA 22020
(703)631-0202

WHITE'S ELECTRONICS' LIMITED WARRANTY

If within two years (24 months) from the original date of purchase your White's detector fails through normal use or due to defects in either material or workmanship, White's Electronics will repair or replace, at its option, all necessary parts without charge for parts or labor.

Simply return the detector to the dealer where you purchased it. The unit must be accompanied by a completed service coupon provided by your dealer. You must provide proof of date of purchase before the unit is shipped.

If the unit has failed within the first 90 days of purchase, shipping will be prepaid.

If the unit fails after the first 90-day period, the customer is responsible for shipping costs. Please also include \$5.00 for return postage, handling and insurance.

Items excluded from this warranty are non-rechargeable batteries, headphones and other accessories.

The warranty is not transferable. Nor is it valid unless the Warranty Registration Card is returned to the factory address below within ten (10) days of original purchase for the purpose of recording that date, which is the actual commencement date of the warranty.

The warranty does not cover damage to detectors caused by accident, misuse, neglect, alterations, modifications or unauthorized service.

Duration of any implied warranties (e.g., merchantability and fitness for a particular purpose) shall not be longer than the stated warranty.

Neither the manufacturer nor the retailer shall be liable for any incidental or consequential damages resulting from defects or failures of the instrument to perform.

Some states, however, do not allow limitations on the length of implied warranties, or the exclusion of incidental or consequential damages. Therefore, the above limitations and exclusions may not apply to you.

In addition, the stated warranty gives you specific legal rights, and you may also have other rights which vary from state to state.

White's Electronics, Inc.
1011 Pleasant Valley Rd.
Sweet Home, OR 97386

CODE OF ETHICS

Treasure hunting is the kind of new hobby that fires the imagination and generates its own enthusiasm. It's the most natural thing in the world to want to dig as fast as you can the minute you hear that first loud unmistakably "good" signal. It will be a real thrill to discover there's treasure right beneath your feet!

But wait a minute! We strongly urge you to adopt a code of ethics which will preserve the environment and also the rights of treasure hunters to operate detectors with as few restrictions as possible.

Before you even begin a search, check the law, ordinance or regulations about hunting on publicly owned sites. Abide by the rules. If the area is private property, get written permission from the owner to search it. You may find he will be more eager to give permission if you suggest sharing your finds with him, or if you offer to search for a specific item he has lost.

ABOUT DIGGING: In lawn areas limit the size of the hole to a maximum of two inches in diameter, cutting a plug of sod which can be easily replaced. After you take your finds, be sure to carefully fill the hole. **HOLES ARE BOTH UNSIGHTLY AND DANGEROUS!**

Detectors designed for locating large and deeply buried objects should be used with discretion - never in the lawn area, and with careful judgement in other locations. Consider the scar you may leave, before you start digging. This will vary a lot from one part of the country to another, depending on local soil and climatic conditions. Public officials and private property owners will be much more likely to allow continued treasure hunting if you do no environmental damage. You may even be able to increase your reputation as an ethical hunter by volunteering to carry out and dispose of whatever trash items you find.

Adoption of these attitudes can only enhance the public's opinion of treasure hunters and assure that many areas, both public and private, remain open to you and your new detector.

white's electronics, inc.

1011 Pleasant Valley Rd. Sweet Home, Oregon 97386

P/N 621-0274

PRINTED IN U.S.A. 5/86